

Article number: 20474B15B10ELS

Description: E+G Two-way clamp mounting - GN 474-B15-B10-ELS

## Measures

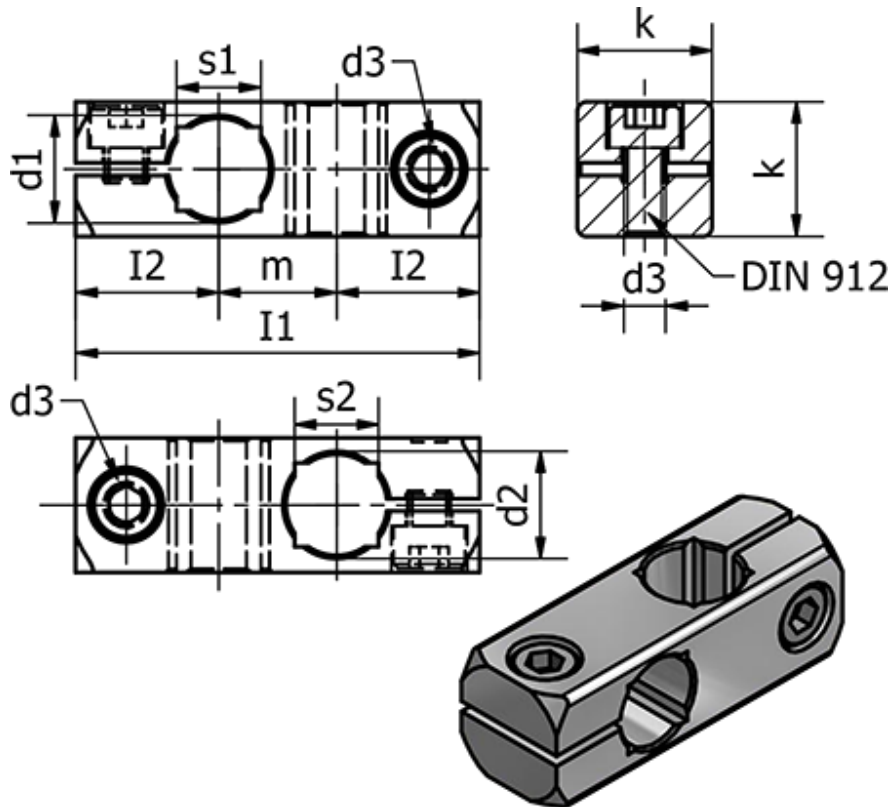

Clamping kit for d3 = GN 511-M6-20

d1 h11 = 15

d2 h11 = 10

d3 = 6

I1 = 58

I2 = 20.5

k = 25

m = 17

s1 = 12

s2 = 8

Weight (g) = 50